

Aina Equipment Supply

Operator's Manual

M380B

Walk Behind Floor Scrubber

Simple Operation | Portable | Reliable



Please read this Operator's Manual carefully and ensure that you fully understand it before using the **M380B Walk Behind Floor Scrubber**.

Important M380B Walk Behind Floor Scrubber General Information and Instructions

Please read this manual carefully before using this product to reduce the risk of fire, electric shock, personal injury, or property damage.

1. Do not operate the machine:

- Unless trained and authorized.
- Unless you have read and understood the operator's manual.
- In flammable or explosive areas.
- If it is not in proper operating condition.
- Outdoors.



2. Before starting the machine:

- Ensure all safety devices are in place and functioning properly.

3. When using the machine:

- Operate slowly on inclines and slippery surfaces.
- Follow all safety guidelines.
- Exercise caution when using the machine in reverse.
- Reduce speed when turning. Repair any damage to the machine before operating it.
- Never allow children to play on or around the machine.
- Do not operate the machine on inclines exceeding 5% (3°).

4. Before leaving or cleaning the machine:

- Stop the machine on a level surface.
- Turn off the machine.

5. When servicing the machine:

- Read the operator's manual thoroughly before servicing.
- Use manufacturer-supplied or approved replacement parts.
- Secure the machine with wheel blocks before jacking it up.
- Use an approved jack or hoist to safely elevate the machine.
- Disconnect the batteries before working on the machine.
- Wear gloves when handling batteries or battery cables.
- Avoid any contact with battery acid.
- Avoid moving parts, and do not wear loose-fitting clothing while servicing the machine.



WARNING: Batteries release hydrogen gas. Explosion or fire can result from hydrogen gas. Keep sparks and open flames away! Keep the battery compartment open when charging.



WARNING: Flammable materials can cause an explosion or fire. Do not use flammable materials in tanks.



WARNING: Flammable materials or reactive metals can cause explosion or fire. Do not pick up flammable materials.

MACHINE SET UP & INSTALLATION

UNCRATING the M380B MACHINE

- Inspect the packing carton for any damage, and immediately report any damage to the carrier.
- Check the package contents to ensure the following items are included:
 - Machine
 - Two 12V batteries (required)
 - Squeegee assembly
 - Battery charger
 - Pad driver

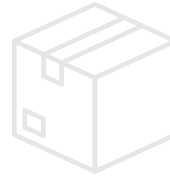

INSTALLING BATTERIES

The batteries are already installed in the machine upon delivery; however you will need to connect the cables to the battery posts.



WARNING: Batteries release hydrogen gas, which can lead to explosion or fire. Keep sparks and open flames away, and always ensure the battery compartment remains open during charging.



1. Ensure the vacuum motor and brush switch are in the OFF position.
2. Open the recovery tank to gain access to the battery compartment.
3. If the batteries were shipped separately from your machine, carefully place the two batteries into the compartment as shown in the diagram below. Place the battery brace at the rear of the two batteries. **DO NOT DROP BATTERIES INTO THE COMPARTMENT.**
4. Connect battery cables to posts in numbered order as shown in drawing below.

RED to POSITIVE and BLACK to NEGATIVE.

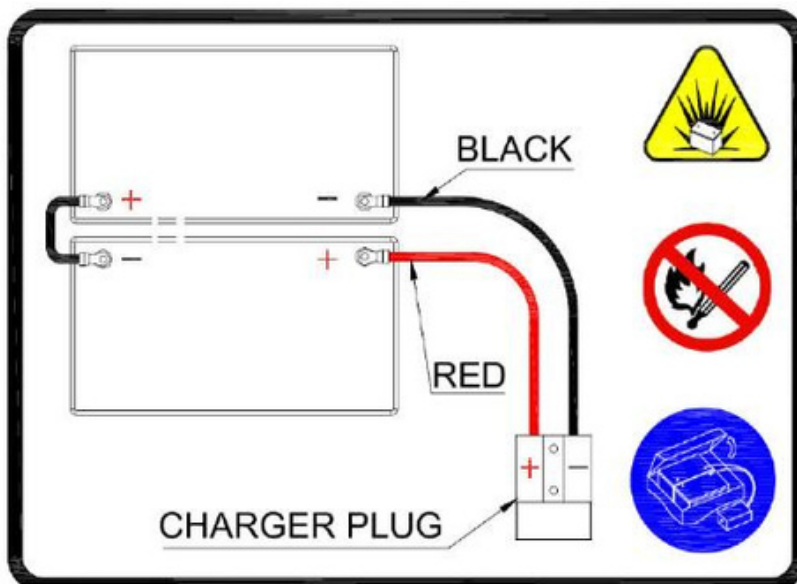

PRE-OPERATION CHECKS and STEPS

1. Sweep or dust mop the surface area to be cleaned before using the automatic floor scrubber.
2. Check the battery meter to ensure the batteries are fully charged. (Refer to the **BATTERY CHARGING** section.)
3. Verify that the squeegee is properly installed.
4. Confirm that the brush or pad is correctly installed.



INSTALLING PAD DRIVER OR BRUSH

1. Ensure the machine is turned off.
2. Press down on the scrub head lift pedal to lift the scrub head off the floor.
3. If using a pad driver, attach the appropriate pad to the pad driver surface first.
4. Mount the pad driver or brush to the brush motor hub by aligning the three studs with the three holes in the brush motor hub. Once aligned, lock them in place by turning the pad driver or brush clockwise. (Pressing the brush button switch on the panel will fully lock the brush or disc.)
5. To remove the brush or disc, disconnect the power supply and rotate the brush or pad driver counterclockwise until it becomes loose.

FILLING THE SOLUTION TANK

The machine is equipped with:

- A hose fill-port at the front of the machine.
- A bucket fill-port at the front of the solution tank.

1. Fill the solution tank to the "13 Gal" level indicated on the solution tank sight gauge (rear of the machine).
2. When using the bucket fill-port, stop filling when the solution level reaches the bottom edge of the fill-port.

NOTE:

When filling the solution tank with a bucket:

- Ensure the bucket is clean.
- Do not use the same bucket for filling and draining the machine.

 **WARNING:** Never place flammable materials into the solution tank, as this could lead to an explosion or a fire. Only use recommended cleaning chemicals. For guidance on the proper chemicals, contact [Aina Equipment Supply](#).

MACHINE OPERATION - Start Up

 **WARNING:** Do not operate the machine unless you have read and understand this manual.

1. Lower squeegee assembly to the floor by lowering the squeegee lift lever, which is located in the middle of the back of the machine.
2. Turn the power button switch or key (see machine panel) to the on (I) position.
3. Check the battery meter (see machine panel), if the battery is showing very low, **DO NOT** continue to operate the machine and recharge the batteries immediately.
4. To change solution flow, use the ball valve to increase or decrease flow rate. When the ball valve is in the horizontal position, the solution flow is OFF. Turn to the valve handle to the vertical position for maximum flow rate.
5. Turn on the vacuum motor switch (see Panel components, item #15). 6. To stop scrubbing, release the control handle bail, raise the scrub head and the squeegee assembly.

WHILE OPERATING MACHINE

 **WARNING:** Fire or Explosion Hazard. Do Not Pick Up flammable materials or reactive metals.

1. Go slow on inclines and slippery surfaces. Do not operate the machine on inclines that exceed 5% (3°).
2. Do not keep the machine in the same position with pad / brush spinning, keep the machine moving to prevent damage to floor finish.
3. If the squeegee assembly leaves streaks on the floor, raise the squeegee off the floor and wipe the blades down with a damp cloth. Pre-sweep the area to prevent leaving streaks on the floor.
4. Pour a recommended defoamer into the recovery tank if excessive foam appears.

LiquidFormula DF DefoamerTreatment Part #NIL-C276-005-E

 **WARNING:** Do not allow foam to enter the float shut-off screen, vacuum motor damage will result. Foam will not activate the float shut-off screen.

5. Occasionally check the battery meter (see Panel components, item #1). When the battery is very low, stop scrubbing and recharge the batteries.

 **WARNING:** When the battery is very low, do not continue to operate the machine. Battery damage may result.

6. When the solution tank runs empty, lift the brush head off the floor, keep the squeegee down, and continue to vacuum until all the dirty water is collected.

NOTE: See **TANK DRAINING** section to learn how to drain recovery and solution tanks.

WHILE OPERATING MACHINE (cont.)

CIRCUITBREAKER

The machine is equipped with a resettable circuit breaker (see machine components, item #18) to protect electronic components. If the circuit breaker trips, it cannot be reset immediately. First identify the cause of the trip, and allow electronic components to cool down before manually resetting the circuit breaker.

NOTE: Contact [Aina Equipment Supply](#) for machine repair service centers in your area.

TANK DRAINING

1. Turn the machine off.
2. With the squeegee and scrub head in their "up" position, transport the machine to an approved area for draining tank(s).

DRAINING THE RECOVERY TANK

Any time scrubbing is completed, or when refilling the solution tank, the recovery tank should be drained and cleaned.

 **WARNING:** If the recovery tank is not drained when the solution tank has been refilled, foam or water may enter the float shut off screen and cause damage to the vacuum motor.

1. While holding the drain hose (see machine components, item #9) upward, remove the cap and lower the hose to drain.
2. Open the recovery tank cover and rinse out the tank. Use a rag to remove any excess dirt.
3. Clean the float shut-off screen and debris tray located in the recovery tank .

DRAINING THE SOLUTION TANK

Any time scrubbing operation is completed, the solution tank should be drained and cleaned.

1. Pull the solution tank level hose (see machine components) off the hose fitting, this will allow the solution to flow freely into a bucket or a floor drain.
2. Remove the cover of the filter assembly (located by the solution control valve bottom of the machine) to drain the solution tank, check the filter screen and clean it if necessary.
3. Rinse the solution tank with clean water after every use. This will help prevent chemical buildup and clogging of the solution lines.
4. After rinsing out the tank, securely reconnect the tank level hose to the hose fitting, replace the filter assembly cover and be sure the filter screen and the "O" ring is in the correct position.

BATTERY CHARGING

 **WARNING:** Batteries release hydrogen gas, which can lead to explosion or fire. Keep sparks and open flames away, and always ensure the battery compartment remains open during charging.

NOTE: Use only approved chargers with the following specifications:

- Automatic shut-off circuit
- Deep cycle charging
- Output current of 10-20 Amps
- Output voltage of 24 volts
 1. Place the machine in a well ventilated area.
 2. Turn the machine off.
 3. If charging wet (lead acid) batteries check the fluid level before charging.
 4. Connect the charger's AC power supply cord to a properly grounded receptacle then connect to the machine's charging receptacle (located on the back of the machine).
 5. Prop up the recovery tank by the support stand (see machine components, item #3) for ventilation when charging.
 6. The charger will automatically begin to charge and will automatically shut-off once the batteries are fully charged.
 7. Upon completion of charging, disconnect the charger AC power supply cord and the charging lead from the machine.

PREVENTATIVE MAINTENANCE



WARNING: Before performing any maintenance on the machine, be sure that the power is turned off, or the batteries are disconnected!

DAILY MAINTENANCE

1. Remove the pad driver or brush and clean with an approved cleaner.
2. Drain recovery and solution tanks completely and rinse with clean water, visually check the recovery tank for debris and clean out as necessary.
3. Raise the squeegee assembly off the floor and wipe it down with a damp towel. Be sure to store the machine with the squeegee in the up position.
4. Remove the float shut-off assembly and rinse it out with clean water.
5. Clean machine with an approved cleaner and a damp towel.
6. Recharge the batteries.
7. Check the condition of the squeegee blade wiping edge, rotate blade if worn.

MONTHLY MAINTENANCE

1. Clean the battery tops to prevent corrosion.
2. Check for loose battery cable connections.
3. Inspect and clean the recovery tank cover seal. Replace if damaged.
4. Lubricate all grease points and pivot points with silicon spray and approved grease.
5. Check the machine for loose nuts and bolts.
6. Check the machine for leaks.

MOTOR MAINTENANCE

1. Contact [Aina Equipment Supply](#) for any motor maintenance.
2. The motor should have the brushes checked every 250 hours. Brushes should be replaced when they are worn to a length of 10 mm ($\frac{3}{8}$ inch) or less.

BATTERY MAINTENANCE



WARNING: Batteries release hydrogen gas, which can lead to explosion or fire. Keep sparks and open flames away, and always ensure the battery compartment remains open during charging.



WARNING: Whenever servicing batteries, be sure to wear protective gloves, avoid contact with battery acid at all times.

NOTE: For optimal performance, keep the batteries fully charged at all times and avoid leaving them in a discharged state.

1. Always follow the battery charging directions as outlined in the BATTERY CHARGING section of this manual.
2. Keep battery tops and terminals free from corrosion.
3. A strong solution of baking soda and water is the most effective way to prevent corrosion. **DO NOT** allow the baking soda/water solution to enter the battery cells.
4. Use a wire brush with the baking soda solution to thoroughly clean the battery posts and connections.
5. Inspect battery connections for signs of wear and loose terminals. Replace them if needed.

MACHINE STORAGE

1. Always store the machine indoors.
2. Always store the machine in a dry area.
3. Always store the machine in its upright position.
4. Always store the machine with the pad driver or brush lifted off the floor.
5. Always store the machine with the squeegee assembly lifted off the floor.
6. If storing in an area which may reach freezing temperatures, be sure to drain all fluids from the machine prior to storage. Any damaged parts caused by freezing temperatures will not be covered by the parts warranty.
7. Drain the recovery tank and solution tank of all fluid.

Main Technical Parameters

| Specification | M380B |
|---------------------------------|-----------------------|
| Scrubbing/Squeegee Width | 14"/19" |
| Solution/Recovery Tank Capacity | 5 gallons |
| Suction Vacuum | 1000mmH2O |
| Brush Motor Power/Speed | 360W/155 rpm |
| Working Time | 3-4 H |
| Total Power Rating | 600W |
| Operating Voltage/Charger | DC2*12V/43Ah |
| Vacuum Motor | 400W |
| Cleaning Efficiency | 1500m ² /h |
| Packing Specification | 32"x21"x26" |
| Dimensions (LxWxH) | 30"x19"46" |
| Machine Weight | 99 lbs |

Parts Identification



Key Components + Controls

- 1. Control Handle
- 2. Recovery Tank
- 3. Recovery Tank Cover
- 4. Solution Tank Fill Cap
- 5. Brush Deck
- 6. Main Power/Key Switch
- 7. Squeegee
- 8. Squeegee Assembly
- 9. Suction Hose
- 10. Rear Wheel
- 11. Control Panel



How to Operate The Machine

1. Turn on the power supply by rotating the key clockwise, and the power indicator light (16) will illuminate.
2. To activate the brush motor, vacuum motor and release the water, press the switches (15, 17).
3. Lower the squeegee release lever, press the suction motor button (15) to activate the squeegee. When finished working, press the button (15), to stop the suction motor, then lift the squeegee.

Last minute checklist before use

1. Check that the hose assembly is properly installed.
2. Check that the brush is installed correctly.
3. Ensure the working surface is sufficient to support the weight of the machine
4. Ensure that the recovery tank cover is closed before use

Troubleshooting

| Problem | Phenomenon | Solve |
|----------------------------------------------------------------|--------------------------------------------------------------------------------------------------------------------------------------------------------------------------------------------------------------------------------------------------------------------------------------------------|----------------------------------------------------------------------------------------------------------------------------------------------------------------------------------------------------------------------------------------------------------------------------------------------------------------------------------------------------------------------------------------------------------------------------------------------------------------------------------------------|
| No Power | No Power Connected | Connected Batter |
| Functional Failure | No electricity, vacuum motor does not work, or brush motor does not work. | Insufficient battery, please charge; or the contactor does not pick up Please check the vacuum motor, related circuits, including motor plugs and relays. Please check the brush motor, related circuits, including motor plugs and relays. |
| The machine does not produce water or emits very little water. | The water valve is closed, the filter is blocked, or the water tank is empty. | Open water valve, cleaning filter, water tank with water. |
| Bad water pick up | Sucking suction hole is blocked, squeegee strip wear, sucking is not installed correctly, damaged pipe (loose or cracked), suction pipe is blocked, the drain cover is loose, the recovery tank cover is open, the recovery tank is full, vacuum motor inlet blockage, or vacuum motor is loose. | Clean sucking hole, replace the new rubber squeegee strip, make sure the sucking is properly installed, replace the suction pipe or re install and tighten the suction pipe, check the hose and clear the blockage, tighten the drain cover, ensure that the recovery tank lid is closed and sealed, empty the recovery tank, check the vacuum motor inlet, clear the blockage, clean the filter cotton, tighten the motor mounting screws, do not over tighten to avoid damaging the motor. |